

ZIP Screen



ZIP Screen





**seamless blend of style
and functionality**

ZIP Screen
Electric fabric roller featuring cutting-edge ZIP
technology, designed to provide efficient shading with a touch
of elegance.

ZIP Screen is a versatile and innovative shading solution, designed to offer precise control over natural light, optimal thermal comfort, and enhanced building aesthetics.

**unveil
shading elegance**

With its sleek and modern design, the screen harmonises with any architectural setting, delivering both elegance and functionality. Meticulously manufactured using state-of-the-art components and premium materials, our screens are built to last, ensuring durability and longevity.



benefits

excellent solar protection

State-of-the-art fabrics that effectively shade and block harmful UV rays.

enhanced thermal comfort

It reduces heat gain while allowing visual transparency and breathability.

energy efficiency

It minimises solar heat gain, reducing reliance on artificial cooling for energy savings.

high aesthetics

It brings a touch of elegance and style to any setting, elevating the overall aesthetic appeal.

customisable design

Wide range of colours, textures and finishes to seamlessly integrate with any window and facade.

top quality and reliability

Crafted with meticulous attention to detail, ensuring exceptional durability and long-lasting performance.

privacy and blackout

It provides precise control over light transmission for desired privacy levels and darkening of internal space.

smart home integration

It can be connected with various smart apps and enable automated control for personalised shading and lighting settings.

shading spaces with exquisite design and unmatched comfort



technical characteristics

box	reel	width		height
Z160	Ø100	7m	x	2.6m
	Ø100	4m	x	5.5m
Z120	Ø78	5.5m	x	2.75m
	Ø78	5m	x	3.4m
Z100	Ø63	3.3m	x	2.6m
Z70	Ø43	2.4m	x	1.5m

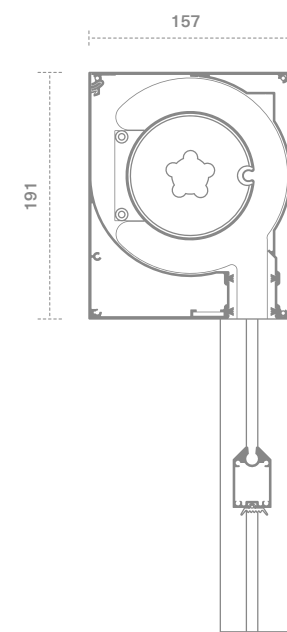
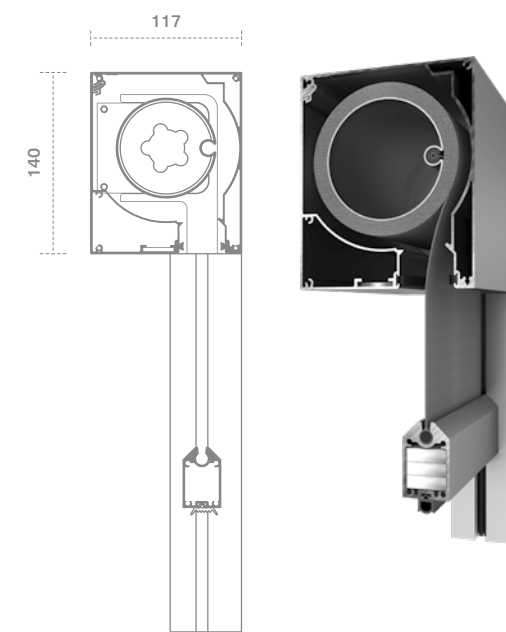
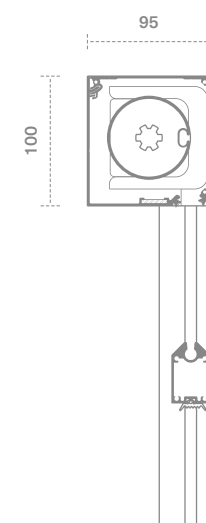
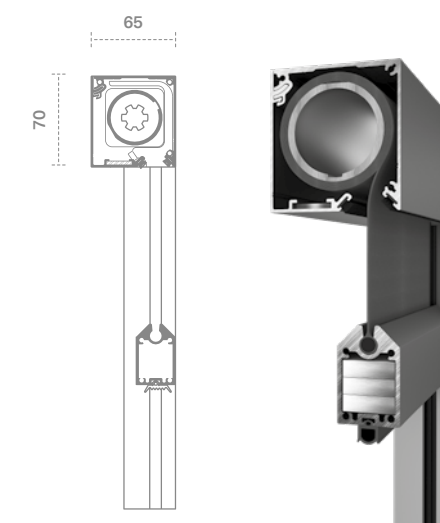
**Z160****Z120****Z100****Z70**

installation & certification



above window system



adjacent to window system

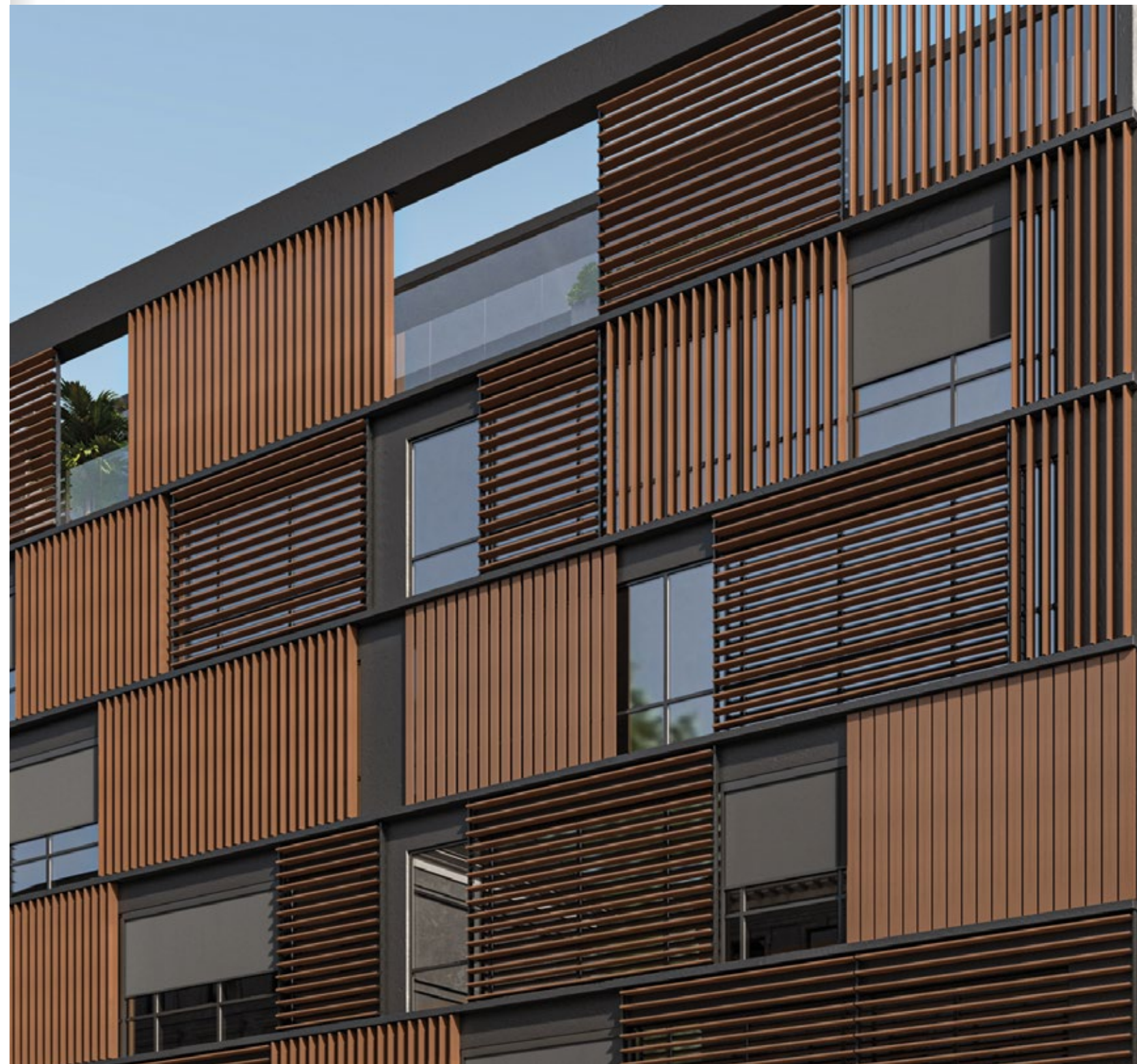

certification

classification

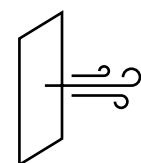

wind load resistance
 max test pressure
 EN 12210 / Class 4
 For dimensions (W x H) 5,7 m x 2,7 m

1 2 3 **4** 5

shading fabrics

the shading fabrics utilized in our ZIP Screens offer exceptional features and advantages

The shading fabrics utilized in our ZIP Screens offer exceptional features and advantages, guaranteeing optimal performance and customer contentment. They are meticulously chosen to cater to the diverse requirements of shading systems, providing a perfect equilibrium between functionality and aesthetics.

their superior specifications include

High UV resistance

Mechanical durability and dimensional stability

Blocking of up to 97% of heat

Up to 28% natural light transmission

Tested and classified for fire resistance

Safe for use (e.g. REACH compliant)

High colour resistance over time

Wide range of colours and textures







Smooth finish and easy clean

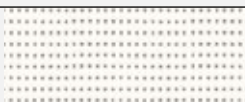
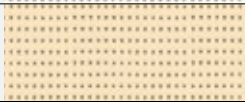
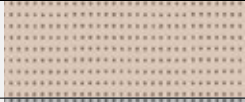

fabric options

Soltis Horizon 86





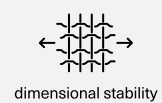
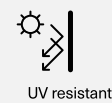
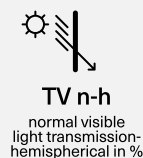
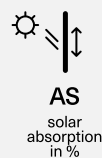
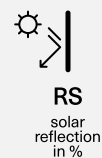
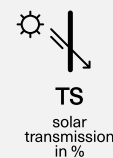

Serge Ferrari
group

code	colour	TS	RS	AS	TV n-h	openness factor	
GLM—04181	white	29	59	12	28	14%	
GLM—04184	champagne	30	57	13	28	14%	
GLM—04183	sandy beige	24	39	37	22	14%	
GLM—04180	alu/alu	19	39	42	19	14%	
GLM—04182	boulder	22	36	42	20	14%	
GLM—04185	concrete	17	14	69	17	14%	
GLM—04177	bronze	15	11	74	15	14%	
GLM—04178	anthracite	17	7	76	17	14%	
GLM—04179	deep black	14	5	81	14	14%	

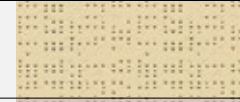
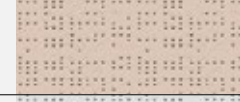
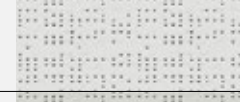

Soltis Perform 92

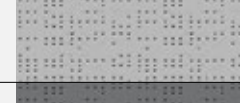
Serge Ferrari
group

code	colour	TS	RS	AS	TV n-h	openness factor	
GLM—04187	white	19	68	13	17	4%	
GLM—04192	champagne	19	65	16	17	4%	
GLM—04196	hemp	9	49	42	6	4%	
GLM—04190	sandy beige	11	46	43	8	4%	
GLM—04195	cloud	12	55	33	9	4%	
GLM—04189	boulder	8	41	51	6	4%	
GLM—04191	alu/white	12	49	39	11	4%	
GLM—04194	alu/alu	8	46	46	8	4%	
GLM—04193	concrete	6	19	75	5	4%	
GLM—04188	anthracite	5	8	87	5	4%	

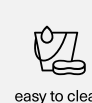
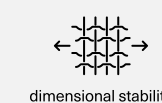
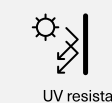
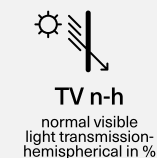
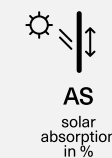
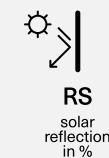
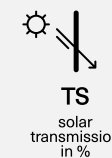

fabric options

SunTex 95

PHIFER

code	colour	TS	RS	AS	TV n-h	openness factor
GLM—04283	white/grey	12	54	34	12	5%
GLM—04284	sand	12	44	44	7	5%
GLM—04285	chestnut	11	39	50	9	5%
GLM—04286	mocha	8	22	70	9	5%
GLM—04287	carbon	6	10	84	10	5%
GLM—04282	dark bronze	8	5	87	11	5%
GLM—04288	black	7	3	90	10	5%

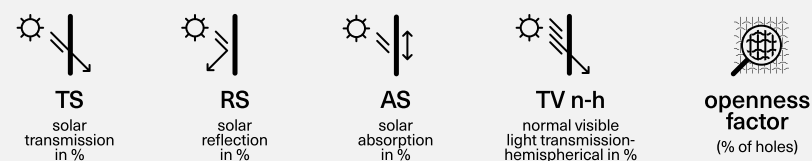
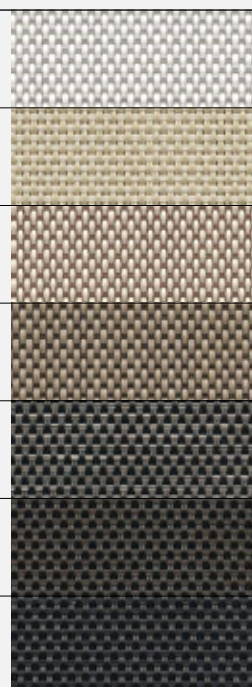

SunTex 97

PHIFER

code	colour	TS	RS	AS	TV n-h	openness factor
GLM—04290	white/grey	9	51	40	7	3%
GLM—04291	sand	9	46	45	5	3%
GLM—04299	chestnut	7	37	56	4	3%
GLM—04292	mocha	4	22	74	3	3%
GLM—04293	carbon	4	11	85	4	3%
GLM—04289	dark bronze	3	5	92	3	3%
GLM—04294	black	3	4	93	3	3%

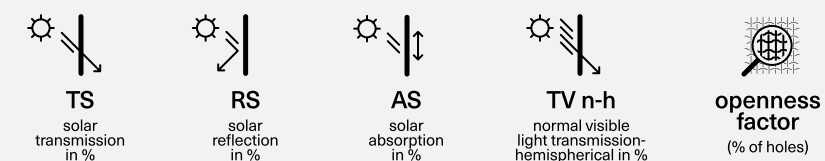
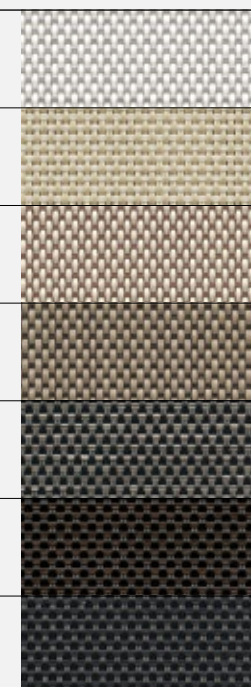

The use of ZIP Screen extends beyond windows to include their application for shading balconies, pergolas, and other structures.

pergola shading



outdoor shading

balcony shading



HEADQUARTERS & FACTORY

Kilkis Industrial Area , Block 11
PO box 19, Kilkis PC 61100

T: +30 23410 71100
E: pergolas@glmhellas.com



Discover all outdoor systems
at glm-outdoor.com



@glmoutdoor



GLM Outdoor Solutions



GLM Outdoor Solutions



